

KINGDOORS

PROVIDED BY

GREENFIELD
Finishing
LLC

Where we enhance the *beauty* of wood

PRODUCT CATALOG



NEW STOCK ITEM

White Oak
Shaker Doors

WWW.GREENFIELDFINISH.COM • VOL. 24



Table of Contents

<i>Know Your Door</i>	3
<i>Stock Doors</i>	5
Glossary	7
White Oak	8
Red Oak	9
Poplar	13
Hard Maple	15
Knotty Alder	17
Knotty Pine	19
Primed	21
Barn Doors	23
Flush Foam Core	25
Clear Pine	31
<i>Quick Ship Doors</i>	27
Stile & Rail	29
Molded	33
Flush	35
<i>Swiss Heritage Series</i>	37
<i>Prehanging Options</i>	43
<i>Hardware</i>	45
Grade 2 Callan Locks	47
Pamex Locks	49
Delaney Levers	50
Pocket Door Locks	50
Elite Hardware	51
Sliding Barn Door Hardware	53
Economy Series	55
LE Johnson Hardware	57
Door Hardware	59
Finish Options	67
Aluminum Sills	69
Manufacturers	71



About

GREENFIELD
Finishing
LLC

MANUFACTURER AND SUPPLIER OF
STANDARD & SPECIALTY INTERIOR
WOOD DOORS & TRIM

Established in 1997, our journey began as we proudly finalized our inaugural trim & door package for a contractor. Prior to this venture, our focus was on crafting & selling both indoor & outdoor furniture. It was a friend who recognized our skills & suggested the idea of establishing a custom finishing company. Accompanying him, we explored local builders, contractors, & millwork shops, gathering inspiration, & from that moment forward, there was no turning back!

In 2021, we expanded our family legacy by acquiring my father's door business, King Doors.

We specialize in delivering exquisite custom finishing, with a keen focus on quality & integrity. We offer a diverse range of door species & styles, including the option for custom designs. From painting & staining to pre-hanging & installation, we provide a full trim & interior door service, catering to every aspect of the process.

Today, Greenfield Finishing is a family-oriented business, & continues to thrive under the daily operation of Abner King & his sons, Dave and Elam.

Know Your Door

Stile & Rail Door -- our stock doors are stile & rail doors which are constructed from horizontal rails and vertical stiles with panels in between. Core and panel type varies by series and manufacturer.

Our area has several small wood shops that produce some of the finest-built hardwood furniture and handcrafted doors, and we are fortunate to be able to utilize products from those manufactures.

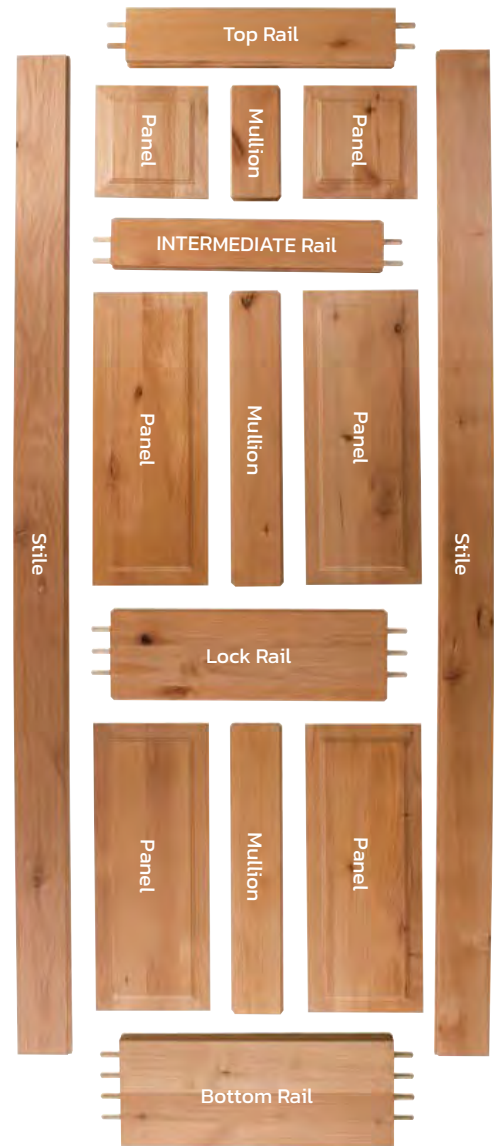

MOLDED DOOR

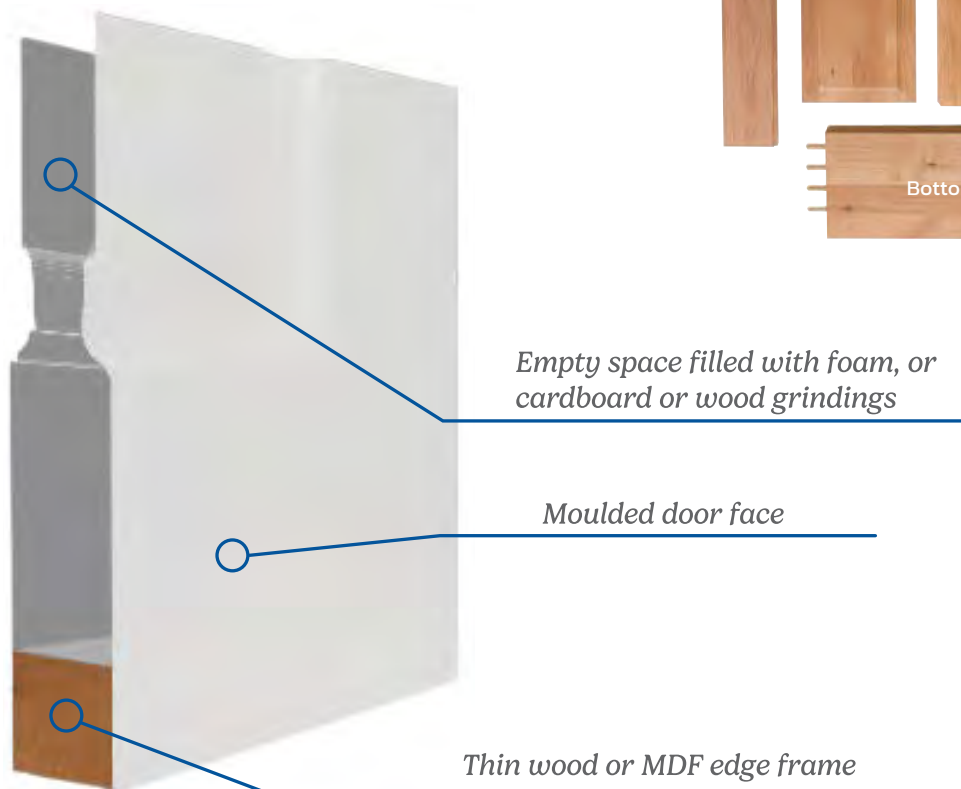

ROUTER CARVED

Premium Router Carved MDF Doors with Over 150 Designs Offered

Woodgrain's Router Carved Door Collection is made of medium density fiberboard (MDF) and include both 1 3/8" and 1 3/4" thick doors available. Router Carved doors offer infinite design options by combining cutting edge technology and old-fashioned craftsmanship.

Door Specifications





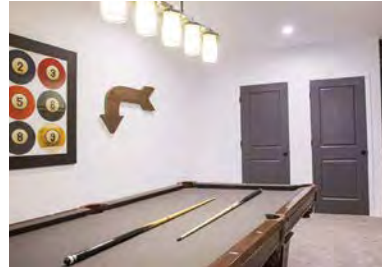

Heights: 6'8", 7'0", 7'6", 8'0" | Width: 1'0" - 4'0"

Thickness: 1 3/8", 1 3/4" | Bifold Doors Available

 20-, 60-, and 90- Minute Fire Doors Available.



Features & Benefits

-  Made in the USA
-  40% Lighter
-  Smooth Paintable Finish
-  Timeless Styles
-  Precision Carved
-  >800 lb Screw Hold Capacity

Design Collection MDF Door Offers

- Exceptionally smooth surface for excellent paint adhesion
- Unlimited design options, including most graphics and text
- Resists shrinkage, expansion or warping
- Environmentally friendly
- SureEdge design for superior screw holding capacity.

Design Collection MDF Door with Expanded Polystyrene (EPS) Core Offer Several Advantages

- 40% lighter than the standard 2'6" x 6'8" MDF door
- Easier to handle and hang
- Exerts less stress on the hinges
- Improve sound transmission properties

Profile and Panel Options

Mix and match any of our five profile options or two raised moulding options.



Raised Moulding

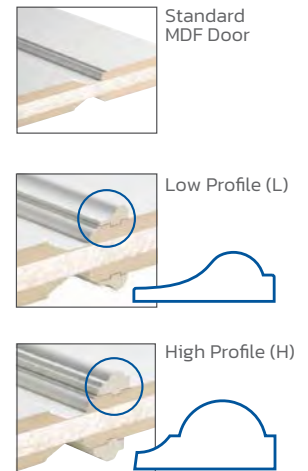

SureEdge

SureEdge solid wood edge band is a feature in each MDF door. Installed in each stile, the SureEdge system allows maximum screw holding power and ease of hinge mortising.



SureEdge



SureEdge



Precision Routing Technology provides crisp line



STOCK DOORS



TABLE OF CONTENTS

White Oak - PAGE 8

Red Oak - PAGE 9

Poplar - PAGE 13

Hard Maple - PAGE 15

Knotty Alder - PAGE 17

Knotty Pine - PAGE 19

Primed - PAGE 21

Barn Doors - PAGE 23

Flush Foam Core - PAGE 25

Glossary



Our "elite" series interior doors are hand-sanded for cross grain marks and also have a formaldehyde free core. Every stile and rail is joined with dowels and glues. The Elite series doors have many features that set them above the competition.



Rustic Series are solid wood doors in Knotty Pine and Knotty Alder. The wood species tends to be a softer wood in which will have imperfections that you will not see in the Elite Series doors. These characteristics might include small dings and dents, small splits or scratches. This is the nature of the Rustic Series, a production run door at an affordable price point.



A pinnacle of craftsmanship in interior doors. Our Exclusive Series features the Flush Foam Core doors, built to our specifications to provide our customers with a superior quality flush door. Available in Oak and Maple options, these doors boast a distinctive combination of elegance and functionality.



These doors offer a practical solution with low maintenance for effortless cleaning. The Economy Grade doors are crafted with a keen focus on delivering a balance between cost-effectiveness and visual appeal.

White Oak

A hard and heavy wood with a medium-bending and crushing strength, low in stiffness, but very good in steam-bending. Hardwood is light to medium brown. The sapwood is light-colored and the heartwood is light-to-dark brown. White oak is mostly straight-grained with a medium-to-coarse texture. Having longer rays than red oak, white oak has more figure.



4020
2-Panel Flat Panel
Shaker

White Oak 4102 2-Panel Shaker + Bravura 904s-1 Lever in Oil Rubbed Bronze

For more White Oak door options see Quick Ship section, page 30

Red Oak

The sapwood of red oak is white to light brown and the heartwood is a pinkish-reddish brown. The wood is similar in general appearance to white oak, but with a slightly less-pronounced figure due to the smaller rays. The wood is mostly straight-grained, with a coarse texture.



Oak 802 2-Panel Arch top Raised Panel

RED OAK DOORS

S
T
O
C
K

D
O
O
R
S

DOOR STYLES AVAILABLE



106
4-Panel Raised



108
6-Panel Raised



802
2-Panel Arch top Raised



4102
2-Panel Flat Shaker



4103T
3-Panel Flat Shaker



Half Lite Clear Glass over 2-Panel Raised

CONTINUES...

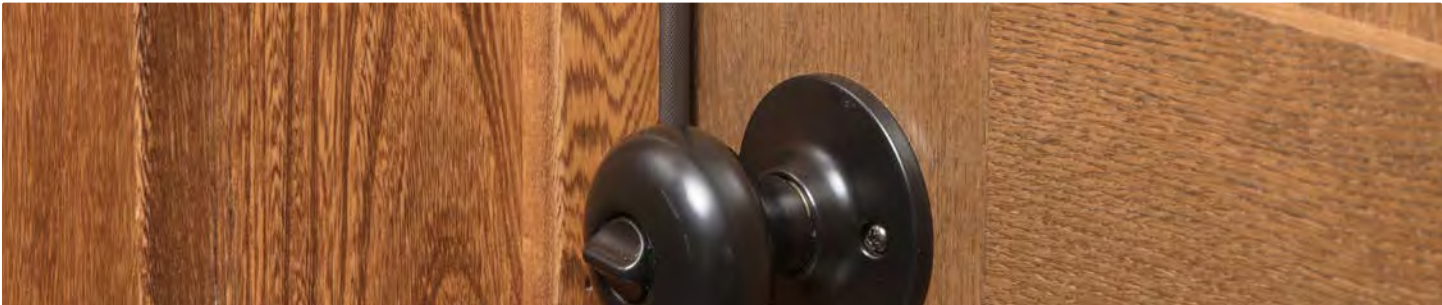

RED OAK DOORS

DOOR STYLES AVAILABLE



9-Lite TDL Prairie Style
Clear Glass



15-Lite V-Grooved



⁶²⁷
15-Lite TDL Clear Glass



⁶⁵²
Fullview Pantry Glass



⁴⁶²⁰
Fullview 1-Lite - Available
in Clear & Frosted Glass

PROFILE STYLES AVAILABLE





Oak 4102 2-Panel Flat Panel Shaker + Saxon Knob US19

Poplar

The sapwood is creamy white and may be streaked, and the heartwood varies from pale yellowish-brown to olive green. The green color in the heartwood will tend to darken on exposure to light and turn brown. The wood has a medium-to-fine texture and is straight-grained.



Poplar 108 6-Panel door + Bravura 903-1 Oil Rubbed Bronze lever



4103T
3-Panel Flat Shaker



4102
2-Panel Flat Shaker

POPLAR DOORS

DOOR STYLES AVAILABLE



102
2-Panel Square
Top Raised



106
4-Panel Raised



108
6-Panel Raised



802
2-Panel Arch top
Raised

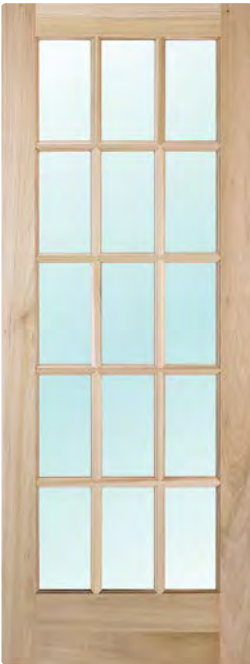

627
15-Lite TDL
Clear Glass



652
Fullview Pantry



4651
Pantry Modern



4620
Fullview - Available in
Clear & Frosted Glass

S
T
O
C
K

D
O
O
R
S

PROFILE STYLES AVAILABLE



Hard Maple

The sapwood is a creamy white with a slight reddish brown tinge, and the heartwood varies from light to dark reddish brown. The wood has a close, fine texture and is generally straight-grained.



Hard Maple 4103T 3-Panel Shaker + Yale Expressions Holden Lever US19

HARD MAPLE DOORS

DOOR STYLES AVAILABLE



4103 T
3-Panel Flat Shaker



4102
2-Panel Flat Shaker

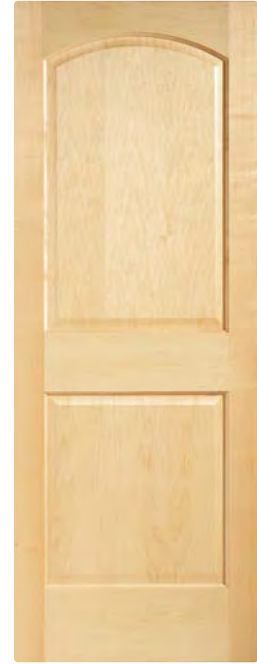

802
2-Panel Arch top Raised

S
T
O
C
K

D
O
O
R
S



108
6-Panel Raised

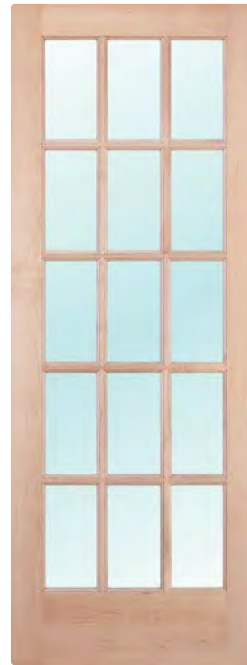

627
15-Lite TDL Clear Glass

PROFILE STYLES AVAILABLE



Knotty Alder

Knotty Alder grows in the Pacific Northwest and is a medium density hardwood with an even grain appearance. The wood is normally light brown with hues of red or peach. Its softer nature makes it easy to machine and receptive to a variety of stains and finishes.



Knotty Alder 4103T 3-Panel shaker + US10BE Bennett Levers

KNOTTY ALDER DOORS

S
T
O
C
K

D
O
O
R
S

DOOR STYLES AVAILABLE



802 DBH
**2-Panel Arch
Top Raised**



802 PLK
**2-Panel Arch
Top V-Grooved**



4103 T
**3-Panel Flat
Panel Shaker**



4102
**2-Panel Flat Panel
Shaker Slab**

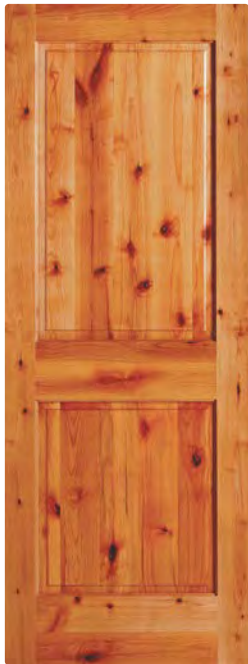

102 DBH
**2-Panel Square
Top Raised**

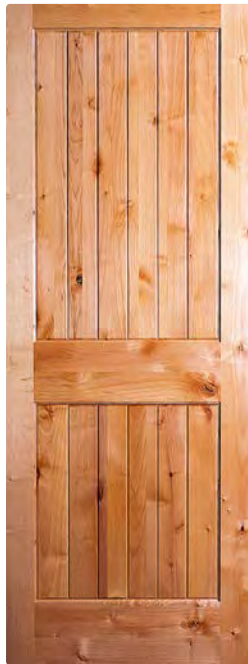

102 PLK
**2-Panel Square
Top V-Grooved**

PROFILE STYLES AVAILABLE



Knotty Pine

Knotty Pine is abundant in America. The wood has a rich display of knots that reflects the randomness and beauty of nature. The wood tends to be a honey-toned or straw color while the knots are generally reddish-brown.



Knotty Pine 2-Panel Square Top V-grooved

KNOTTY PINE DOORS

S
T
O
C
K

D
O
O
R
S



DOOR STYLES AVAILABLE



108
6-Panel Raised



102 PLK
**2-Panel Square Top
V-Grooved**



802 PLK
**2-Panel Arch top
V-Grooved**

PROFILE STYLES AVAILABLE



Primed

Primed options allow for a better paint finish and color match process for any project. Stile & Rail Primed doors are built with Wood Stave Core Stile & Rails and are produced with MDF Veneer and panels for superior paintability. MDF Design Collection Router Carved doors are also available and offer a seamless, uniform finished product. – See our custom section for Woodgrain MDF router carved doors.



Primed 4103T 3-Panel Shaker + Hardware by others

PRIMED DOORS

DOOR STYLES AVAILABLE



4102
2-Panel Flat Shaker



4103T
3-Panel Craftsman Flat Shaker



4103
3-Panel Equal Flat Shaker

S
T
O
C
K

D
O
O
R
S



4107
5-Panel Equal Flat Shaker



627
15-Lite TDL Clear Glass

PROFILE STYLES AVAILABLE



Barn Doors

Barn doors make a wonderful functional accent piece for a wide variety of rooms – from closets to kitchens to bedrooms and more, there are so many possibilities. Any door on a rail can technically be considered a barn door and the style extends beyond the classic rustic look. Barn doors complement modern, industrial, and traditional interiors as well.



Knotty Alder 180 Barn Doors

*Complements Modern, Industrial,
& Traditional Interiors Styles.*

**FIND BARN DOOR
ACCESSORIES ON
PAGES 53-56**



BARN DOORS

S
T
O
C
K

D
O
O
R
S



DOOR STYLES AVAILABLE



180
**Knotty Alder 1-Panel
V-grooved with Diagonal
Crossbuck**

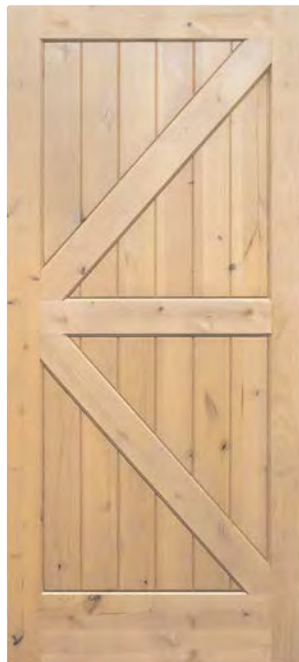

181
**Knotty Alder 2-Panel
V-grooved with Arrow
Crossbuck**



4180
**Primed 1-Panel Flat
Panel with Diagonal
Crossbuck**



4181
**Primed 2-Panel Flat
Panel with Arrow
Crossbuck**

Flush Foam Core

Our Flush Foam Core doors are built to our specs to give our customers a better quality flush door. Available in Oak & Maple. With a MDF back plywood skin these doors give you a more consistent finish quality. The Foam Core makes the door lighter than a Solid Core but has a better sound deadening rating than Hollow Core.



FLUSH FOAM CORE DOORS

S
T
O
C
K

D
O
O
R
S



DOOR STYLES AVAILABLE



Maple Flush

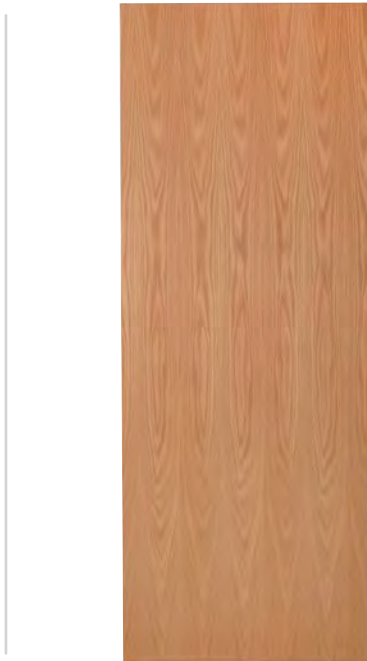

Oak Flush

**FLUSH DOOR WITH
FOAM CORE AND
SIDE STILES IN
MATCHING SPECIES**



FLUSH FOAM CORE

Flush doors offer a sleek and versatile look to many decors.



QUICK SHIP DOORS



TABLE OF CONTENTS

Stile & Rail - PAGE 29

Molded - PAGE 33

Flush - PAGE 35

Stile & Rail

DOOR STYLES AVAILABLE

POPLAR



4020
1-Panel Flat Panel Shaker



4103
3-Panel flat Panel Equal



4603
3-Lite Equal
Clear Glass or White Laminated Glass



4605
5-Lite Equal
Clear Glass or White Laminated Glass

DOOR STYLES AVAILABLE

PRIMED



4020
1-Panel Flat Panel Shaker



4620
Full-view
Clear & Frosted Glass



4603
3-lite Equal
Frosted Glass



4605
5-lite Equal
Frosted Glass

Stile & Rail quickship doors are stocked at our manufacturer and are available with quicker leadtimes than custom. Most styles are only available in standard sizes. call for current leadtimes.

DOOR STYLES AVAILABLE

KNOTTY ALDER



108
6-Panel Raised DBH

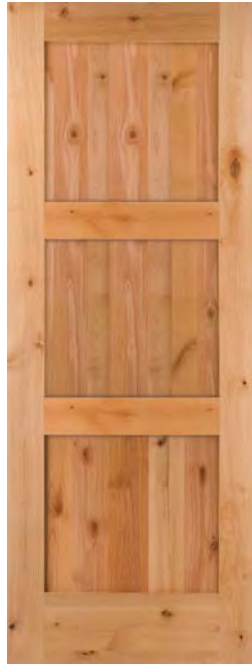

4103
3-Panel flat Panel



4107
5-Panel flat Panel Shaker

KNOTTY PINE

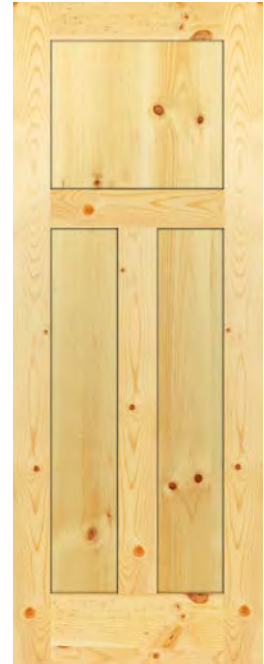

4103T
3-Panel Flat Panel Shaker

DOOR STYLES AVAILABLE

WHITE OAK



4020
1-Panel Flat Panel Shaker



4103
3-Panel flat Panel Equal



4107
5-Panel Flat Panel Shaker



4103T
3-Panel Flat Panel Shaker

QUICKSHIP DOORS

CONTINUES...

Stile & Rail

DOOR STYLES AVAILABLE

FIR



4020
1-Panel Shaker



4102
2-Panel Shaker



4103
3-Panel Equal Shaker



4103T
3-Panel Craftsman Shaker



4107
5-Panel Equal Shaker

CLEAR PINE



106 RAD
4-Panel Raised Panel



802 RAD
2-Panel Archtop RP

CLEAR PINE



108 RAD
6-Panel Raised Panel



A hard and heavy wood with a medium-bending and crushing strength, low in stiffness, but very good in steam-bending. Mostly straight-grained with a medium-to-coarse texture. Having longer rays than red oak, white oak has more figure.

WHITE OAK

The sapwood is light-colored while the heartwood is light-to-dark brown.



Molded

Molded doors are an economical option for interior doors. They are stamped by a mold into a hardboard fiber material to create the door desired panel design. They are manufactured to resemble the look of an interior stile and rail wood doors. Each door model has a specific panel type, sticking type, and surface. Unlike our stile and rail primed doors molded doors do not have stile and rail intersections and therefore create a nicer finished product. Another option is Woodgrains Router Carved Door, see our custom door section.



Madison 1-Panel Flat Panel

MOLDED DOORS

DOOR STYLES AVAILABLE

QUICKSHIP DOORS



**Caiman 2-Panel
Arch top Raised**



**Carrara 2-Panel
Square top Raised**



**Colonist 6-Panel Raised
Smooth or Textured**



**Santa-Fe 2-Panel
Arch top V-Grooved**



**Conmore 5-Panel
Flat Horizontal**



Craftsmen 3-Panel Flat



Madison 1-Panel Flat



Monroe 2-Panel Flat



Flush

Flush Wood doors are a economical option with low maintenance for cleaning. With a rich look and two types of wood grains — oak, and birch — you'll find the perfect choice for any décor.



Birch Flush Solid Core – Customer Supplied Hardware

FLUSH DOORS



DOOR STYLES AVAILABLE



Birch Flush

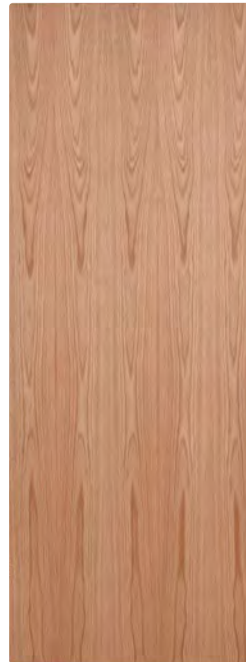

Oak Flush

FLUSH DOOR OPTIONS

HOLLOW CORE &

SOLID CORE

Flush doors offer a sleek and versatile look to many decors.



SWISS HERITAGE SERIES



Swiss Heritage Series

The Swiss Heritage Series doors are locally manufactured by Amish craftsmen.

These doors are made in a stile & rail build. Because these doors are solid wood stave core, you get your choice of any native hardwood specie. Door thickness is 1 3/8" standard, with options up to 2 1/4" thick. Panels are 3/4" thick, made of solid wood and also available up to 1 1/4" thick. The door has better stability when using stave core versus using a solid piece of hardwood for stiles and rails.

Doors are pre-hung on matching solid wood specie of your choice, with plenty of different hinge and hardware options to choose from.



Custom Rustic White Oak Barn Door + Strap Trolley Barn Door hardware

SWISS HERITAGE SERIES DOORS



Elm 4-Panel Flat Shaker



Spanish Cedar 4-Panel



Rustic QSWO 3-Panel Flat Shaker



Rustic Soft Maple 6-Panel Raised



Rustic White Oak 3-Panel Flat Shaker



Quarter Sawn White Oak 3-Panel Flat Shaker







Prehanging Options

DOOR STOP OPTIONS

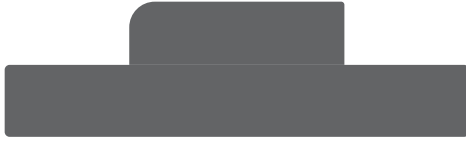

SQ Eased Applied



Colonial Applied

***If STOP LOOSE**
option to prep jamb for screws
behind door stop



SQ Eased Stop Loose *



Colonial Stop Loose *

EMTEK®

*Upgrade to Emtek Heavy Duty
Ball Bearing Hinges*

*Available in Square Corner or 5/8 Radius
in all standard Emtek Finishes*

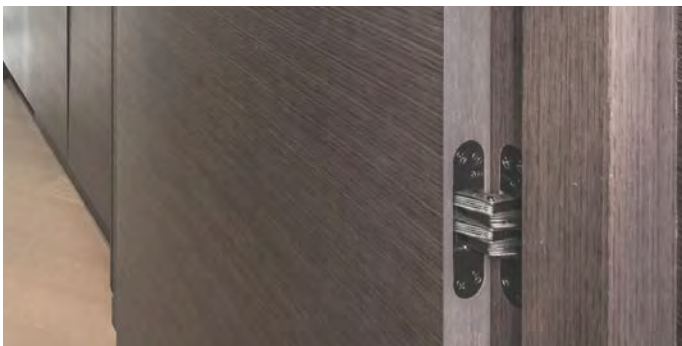

SOSS®

Door Hardware

*Update to SOSS Concealed
Hinges in any color & finish*

INSTALL SILL & SWEEP



INSTALL PEMKO 411ARL



PREP FOR QLON WEATHERSTRIP

Behind Door Stop

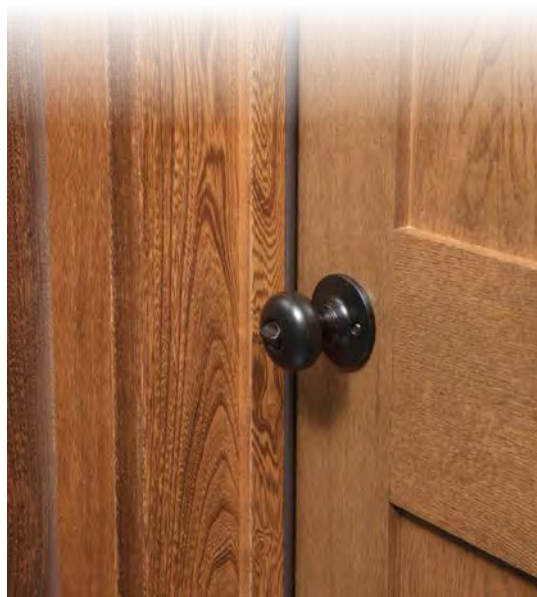



HARDWARE



TABLE OF CONTENTS

<i>Grade 2 Callan Locks</i>	- PAGE 47
<i>Pamex Locks</i>	- PAGE 49
<i>Delaney Levers</i>	- PAGE 50
<i>Pocket Door Locks</i>	PAGE 50
<i>Elite Hardware</i>	- PAGE 51
<i>Sliding Barn Door Hardware</i>	- PAGE 53
<i>Economy Series</i>	- PAGE 55
<i>LE Johnson Hardware</i>	- PAGE 57
<i>Door Hardware</i>	- PAGE 59
<i>Finish Options</i>	- PAGE 67
<i>Aluminum Sills</i>	- PAGE 69

Grade 2 Callan Locks

Callan 2 residential door locks are available in 5 finishes. Easy to install using adjustable backsets and reversible functions, you can update your outdated locks without any hassle. Lincdor stocks a Bentley lever and Sawyer knob in entry, privacy, passage and dummy functions. Handle sets and deadbolts are also in stock. Keyed locks are provided with a Schlage keyway.



SATIN NICKEL
Bentley Lever US15



OIL RUBBED BRONZE
Bentley Lever US10BE



ANTIQU BRASS
Bentley Lever US5



BRASS
Bentley Lever US3



BLACK
Bentley Lever US19



BRASS
Deadbolt US3



ANTIQU BRASS
Deadbolt US5



BLACK
Deadbolt US19



OIL RUBBED BRONZE
Deadbolt US10BE



SATIN NICKEL
Deadbolt US15



BRASS
Sawyer Knob



ANTIQUE BRAS
Sawyer Knob



OIL RUBBED BRONZE
Sawyer Knob



SATIN NICKEL
Sawyer Knob



BLACK
Sawyer Knob

Easy to install using adjustable backsets and reversible functions. You can update your outdated locks without any hassle.

SCHLAGE KEYWAY

Extra Keys Available
Master Keying Available

All locks shown are **STOCKED** at Lincdor



ANTIQU BRASS
Colton Handleset

OIL RUBBED BRONZE
Colton Handleset

SATIN NICKEL
Colton Handleset

BLACK
Colton Handleset

BRASS
Colton Handleset

***LIMITED AVAILABILITY**

***LIMITED AVAILABILITY**

Pamex Locks

Our stock Pamex Locks are a Grade 2 Residential lock with a modern design lever available in Black and Nickel. Pamex locks come with a Lifetime mechanical non transferable warranty available to the original homeowner. Locks are stocked with a Schlage keyway and can be keyed to our other locks that we sell. The Alto lever is also available with a Square Rosette as a special order item. For the past 35 years, Pamex has supplied residential and commercial hardware to numerous prominent single-family, multi-family and commercial building projects.



US15 / SATIN NICKEL
Alto Lever



US19 / BLACK
Alto Lever



US15 / SATIN NICKEL
FDS Deadbolt



US19 / BLACK
FDS Deadbolt



US15 / SATIN NICKEL + BLACK
Troy Handle set

Delaney Locks

Lashbrook Levers are stocked in US15 Satin nickel, US19 Black & US12P Tuscany Bronze in Entry, Privacy, Passage & Dummy Functions.

Levers have a Grade 2 rating with a Square Drive and perform better than the bennet lever but is not as competitively priced. Locks have Schlage keyways so they can be keyed to match our other stock items.

Handlesets, Combo Sets and Deadbolts are available to order with short leadtimes.



TUSCANY BRONZE
Lashbrook



SATIN NICKEL
Lashbrook



BLACK
Lashbrook

Pocket Door Locks

Pocket door locks are an excellent choice to purchase due to their practicality, space-saving benefits, and aesthetic appeal. Designed specifically for pocket doors, these locks are discreet and seamlessly integrated, allowing doors to slide smoothly into wall cavities when opened. This unique mechanism maximizes usable space by eliminating the need for swing clearance associated with traditional doors. Pocket door locks provide privacy and security, ensuring that rooms can be easily separated when needed.

US10B / OIL RUBBED BRONZE
Round Pocket Door Lock



US10B / OIL RUBBED BRONZE
Square Pocket Door Lock



Finishes Available

- BRS
- AB
- BLK
- ORB
- SN

Elite Hardware

ASHLEY NORTON

- Ashley Norton Solid Bronze and Solid Brass locks are manufactured using the finest grade raw materials and are available in multiple styles and finishes.
- European engineering and design, with spring assisted levers to eliminate lever sag.
- Our highest grade lock. These are a good option for those high end projects that demand quality and performance.
- All locks have fixed backset and come with a 28 degree rotation latch.
- 10 year mechanical warranty to the original purchaser.

Call for literature and pricing.

Ashley Norton
ARCHITECTURAL HARDWARE

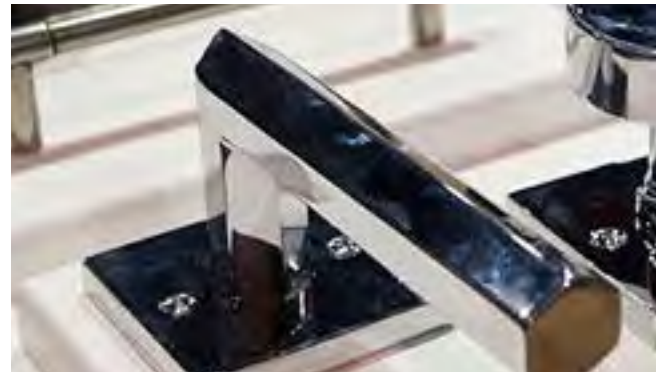

BRAVURA

- Bravura is a complete line of Solid Brass Interior and Exterior door locks including handlesets.
- High end quality with a more limited line of knobs and levers to choose from than some of its competitors.
- All locks come with fixed backset. Products are pre-configured for expedited order fulfillment and shipping.
- Bravura comes with a lifetime mechanical warranty and a 5 year Finish Warranty.
- See Bravura full line product catalog for more information.



Bravura

EMTEK

- Emtek has one of the most extensive lock lines in the industry. they have many knob / lever styles and offer all the trendy finishes.
- Our go to lock on most projects looking for a good quality lock as an upgrade to our stock.
- All locks have fixed backset with option for 28 degree rotation latch and concealed fastener.
- We can prep your job for any of these options, **Call for more information.**
- Limited Lifetime non transferable warranty to the original purchaser.

EMTEK®



E
L
I
T
E

H
A
R
D
W
A
R
E

MONTANA FORGE

- Montana line of solid steel locks where you can mix and match rosettes with any knob or lever style in any finish
- A more condensed line, they have 5 finish options available and 7 levers and 5 knobs with 6 different rosettes.
- All locks are 28 degree rotation latch and concealed fastener.
- **New for us in 2024** - A great option to upgrade your lock at a fraction of other solid brass hardware lines
- Limited lifetime mechanical warranty for as long as original purchaser occupies the home.

Call for more information and literature.

Lincdor offers a range of higher end locks at an upgrade with short lead times
Contact Lincdor sales team for info & pricing

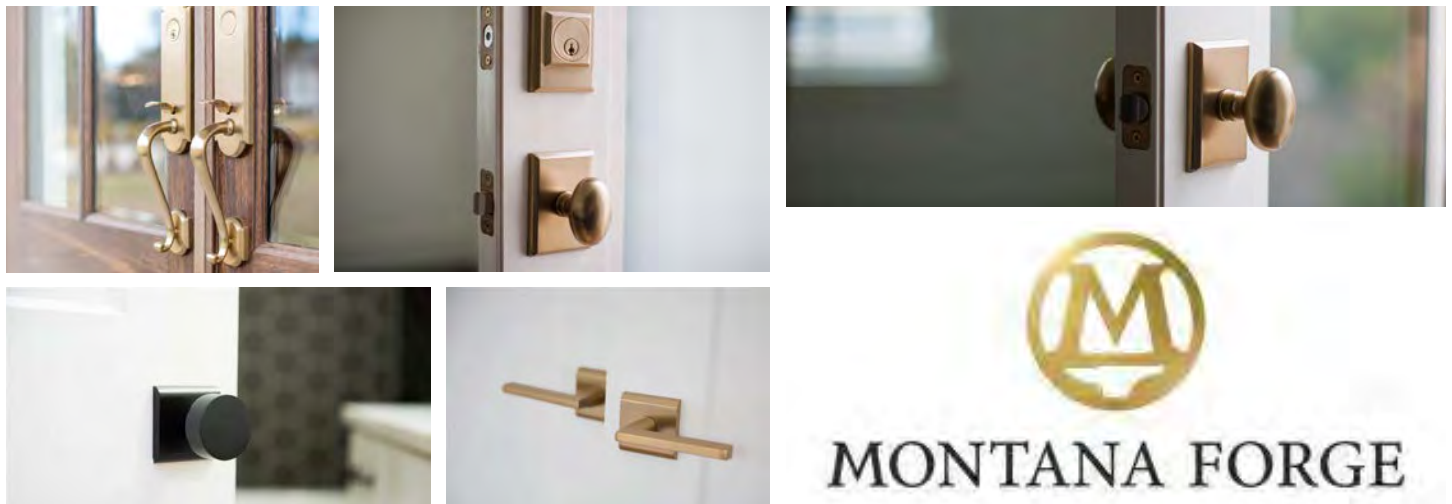

MONTANA FORGE

Sliding Barn Door Hardware



Manufactured in Ohio using heavy duty forged steel hangers with brass bushings, our barn door hardware is made to last a lifetime. Available in Powder coated Black, the hardware kits are available in four different trolley styles; Wagon Wheel, Horseshoe, Strap & Pulley Trolley. Standard kit sizes are 4' through 12' in 1' increments.. Custom track lengths are available with extended lead times. Kits come complete with track, mounting brackets, hangers, floor guide, track mounted stop & all screws needed for installation.



BLACK
Wagon Wheel Trolley



BLACK
Horseshoe Trolley



BLACK
Pulley Trolley



BLACK
Strap Trolley



BLACK
Wall Mount Roller Guide



BLACK
Wall Mount J-Guide



BLACK
Standard Floor Guide



BLACK
T-Guide



BLACK
Floor Mount Stop
Left and/or Right



BLACK
Privacy Latch



BLACK
10" Barn Door Pull



BLACK
Square Contemporary
Barn Door Pull



BLACK
Wall Mount Stop



BLACK
Clamp On Track Stops

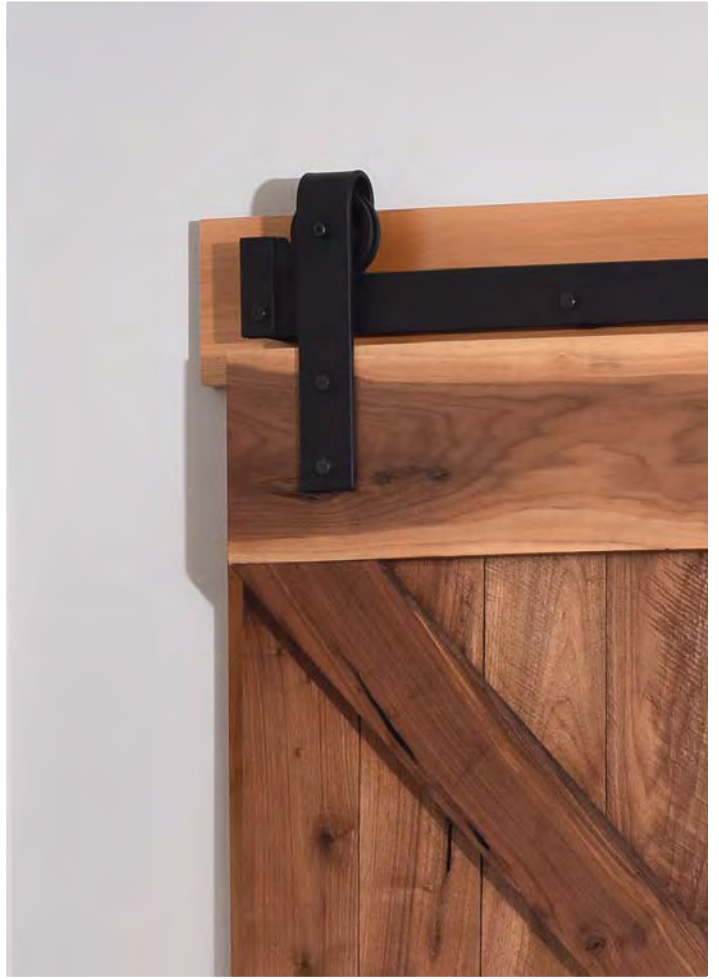

H
A
R
D
W
A
R
E

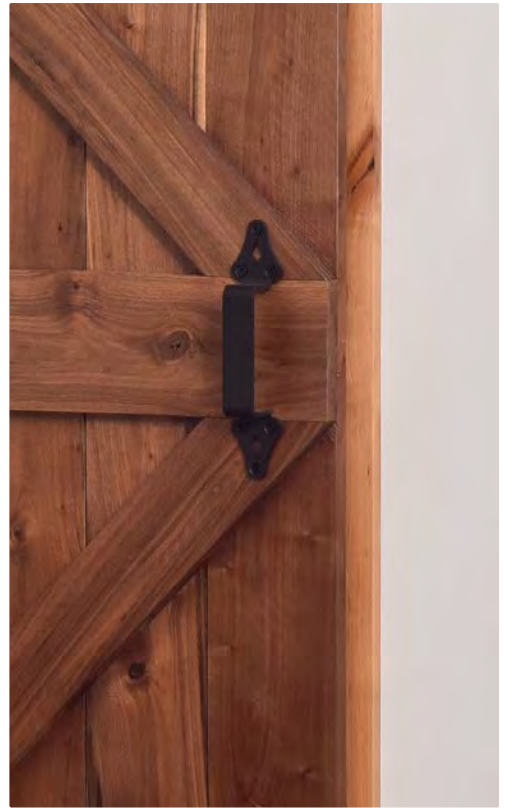

Economy Series

This hardware will accommodate doors that are 1 3/8" thick. Only available in Black. These kits come prepackaged with all necessary parts and hardware in one convenient box. This product allows you to offer your customers a more cost effective sliding barn door hardware system.



LX-01
Strap Trolley
Stock: 6', 7' & 8'



LX-06
Top Mount Trolley
Stock: 6'



LC-15
Tack Connector



LC-20-C
**Softy-Close System
w/ Mounting Clip**



HD-05
Handle



HD-16
Handle



LE Johnson Hardware

In stock is their bi-fold hardware in 100FD Series, 111FD Series & 1700 Series along with 138F Bypass Hardware and 1500 Pocket Door Kits. Some options now available with Soft Open / Close.



POWERED BY
ENDURA 



PANOLOCK+
MULTI-POINT LOCK

PanoLock®+ is the first and only multi-point lock that works with a wide variety of off-the-shelf hardware, including electronic deadbolts!

That's affordable security and performance for every entry door.



THUMB PRESS, LEVER OR KNOB. EVEN ELECTRONIC DEADBOLTS.

Matching hardware throughout the house is now a possibility.

PanoLock+ is the multi-point lock you've been waiting for.

Door Hardware

HARDWARE FINISH COLORS AVAILABLE

*AVAILABILITY VARIES PER PRODUCT



SEE PAGE 67 FOR
LARGE COLOR SWATCHES

MAGNETIC CATCH



Finishes Available



BALL CATCHES



Finishes Available



HANDRAIL BRACKET

US15
Solid Diecast Heavy Duty



Finishes Available



SURFACE BOLTS

SOLID BRASS
4" Surface Bolt



Finishes Available

- ORB
- SN
- ANB

EMTEK 8511
6" Surface Bolt



Finishes Available

- BLK
- ORB
- SN

EMTEK 8512
12" Surface Bolt



Finishes Available

- BLK
- ORB
- SN

EMTEK 8516
4" Dutch Door Bolt



Finishes Available

- ORB
- BLK
- N
- ANB

FLUSH BOLTS

US15 / SATIN NICKEL
6" Flush Bolt



Finishes Available

- BLK
- ORB
- SN
- ANB
- BB
- SC

12" Extended Flush Bolt



Finishes Available

- ORB
- BC
- ANB
- BB
- SC
- BLK

RECESSED PULLS

US19
2 1/8" Cup Pull



Finishes Available



2201
Emtek Recessed Flush Pull



Finishes Available



EDGE PULLS

US15
Johnson 150 Series Edge Pull



Finishes Available



2221
Emtek Edge Pull



Finishes Available



DOOR STOPS

US10B
Hinge Pin Door Stop



Finishes Available

- BLK
- ORB
- SN
- ANB
- BB

US15
Concave Wall Stop



Finishes Available

- ORB
- SN

US19
3 1/4" Spring Door Stop



Finishes Available

- BLK
- ORB
- SN
- ANB
- BB

US15
2 1/2" Diecast Door Stop



Finishes Available

- BLK
- ORB
- SN
- ANB
- BB

HINGES 3½"

SHOWN IN US10C

Steel Hinges - Plain Bearing - ⅜" Radius



Finishes Available



SHOWN IN US26D

Steel Hinges - Ball Bearing - ⅜" Radius



Finishes Available



US3

Steel Hinges - Plain Bearing - ⅜" Radius



Finishes Available



US10B

Steel Hinges - Plain Bearing - Square Corner



Finishes Available



US19

Spring Hinges - ⅜" Radius



Finishes Available

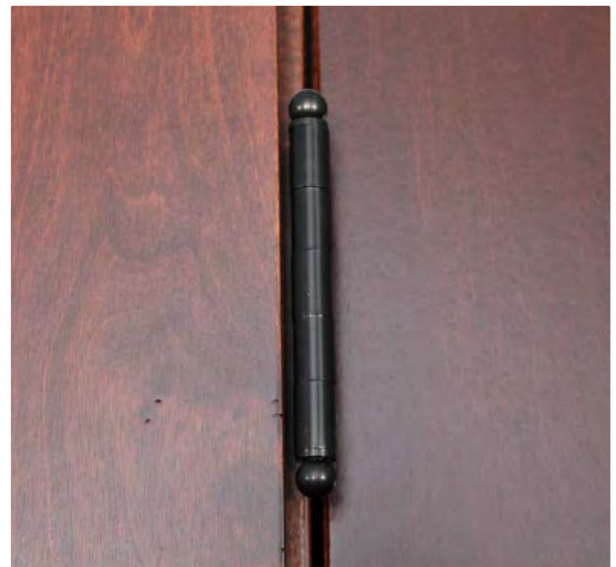

HINGES 4"

US15

Steel Hinges - Ball Bearing - 5/8" Radius



Finishes Available

- ANB
- BLK
- OAB
- SB
- SN

US26D

Spring Hinges - 5/8" Radius



Finishes Available

- ANB
- BB
- ORB
- SN

HINGES 4 1/2" COMMERCIAL USE

US3

Steel Hinges - Ball Bearing - Square Corner



Finishes Available

- BLK
- BB
- AB
- ANB
- SN

US10B

Spring Hinges - Square Corner



Finishes Available

- BB
- ANB
- ORB
- SN

HINGE FINISH COLORS AVAILABLE

*AVAILABILITY VARIES PER PRODUCT

- AGED BRONZE
- ANTIQUE BRASS
- ANTIQUE NICKEL
- BLACK
- BRIGHT BRASS
- BRUSHED CHROME
- BRUSHED NICKEL
- NICKEL
- OIL RUBBED BRONZE
- SATIN NICKEL
- SHINY CHROME
- SILVER

SEE PAGE 67 FOR
LARGE COLOR SWATCHES

EMTEK STEEL HINGES

94033

3½" x 3½" x ⅝" Radius. Steel Heavy Duty Ball Bearings



94013

**3½" x 3½" x Square Corner
Steel Heavy Duty Ball Bearings**



94034

4" x 4" x ⅝" Radius. Steel Heavy Duty Ball Bearings



94014

**4" x 4" x Square Corner
Steel Heavy Duty Ball Bearings**



94015

**4½" x 4½" x Square Corner
Steel Heavy Duty Ball Bearings**



EMTEK®

*MORE SIZES & FINISHES AVAILABLE,
SEE EMTEK CATALOG*

EMTEK SOLID BRASS HINGES

96415

**4½" x 4½" x Square Corner
Solid Brass Commercial Ball Bearing**



96416

**5" x 5" x Square Corner
Solid Brass Commercial Ball Bearing**



H
A
R
D
W
A
R
E



Finish Options

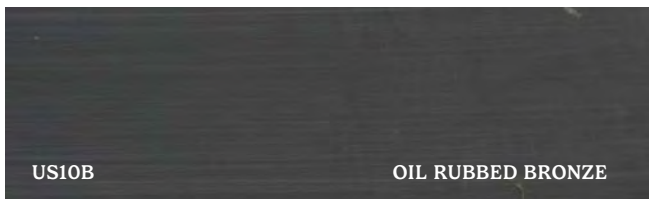
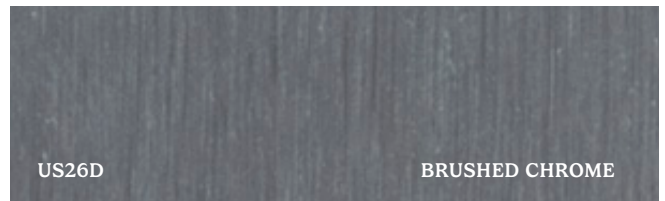
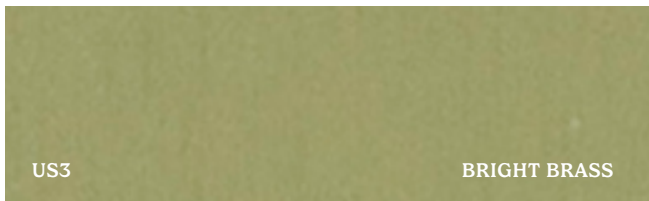

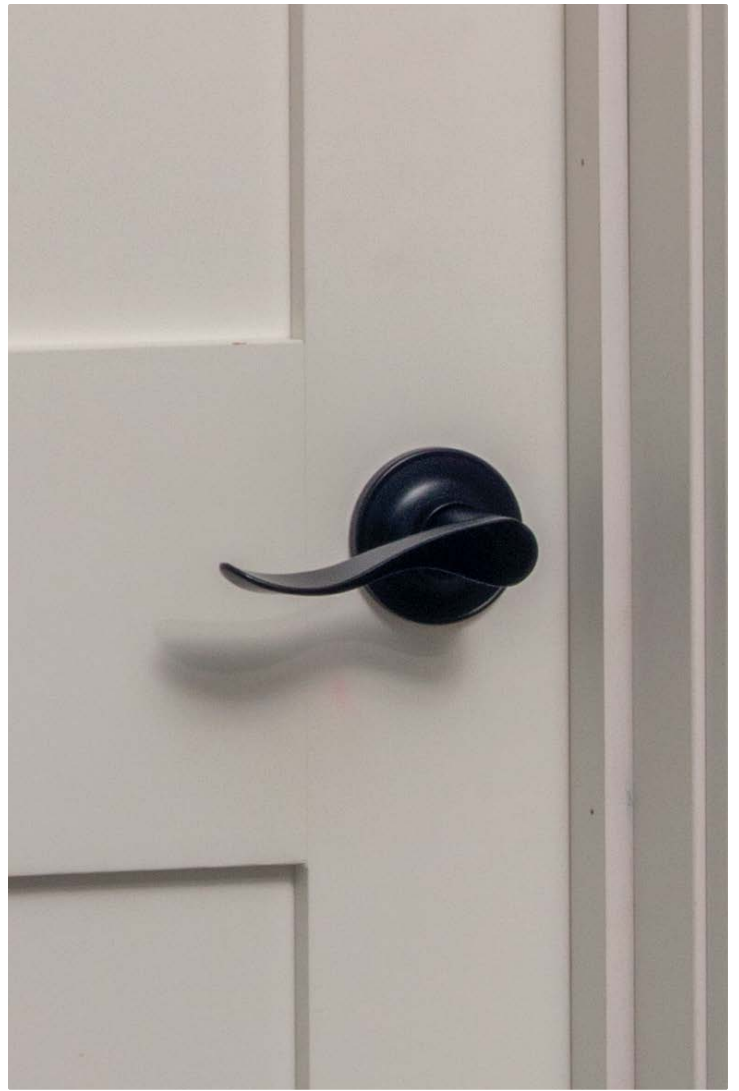

Aluminum Sills

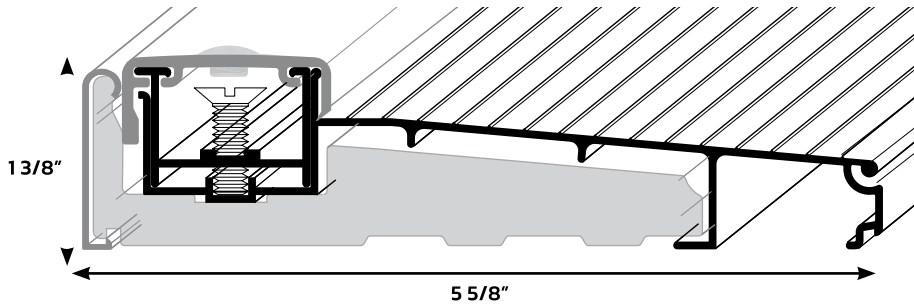

901
Composite Inswing Sills

Bronze
Mill Finish Aluminum

SIZES AVAILABLE
30" - 32" - 36" - 74" - 148"

901

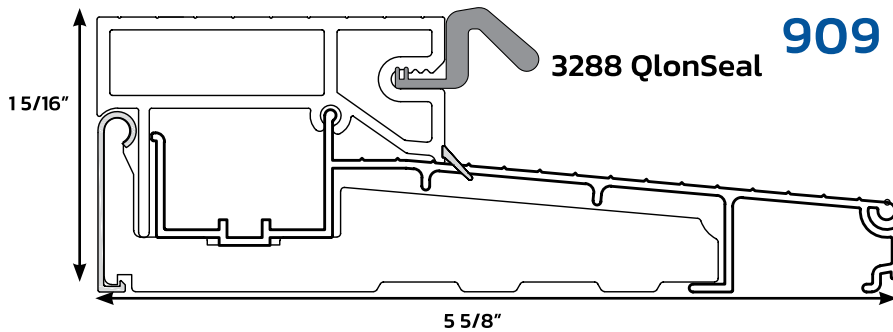

909
Composite Outswing Sills

Bronze
Mill Finish Aluminum

SIZES AVAILABLE
36" - 74" - 148"

909

3288 QlonSeal

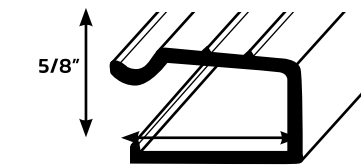

325

3/4" ext - Bronze & MF - 74"

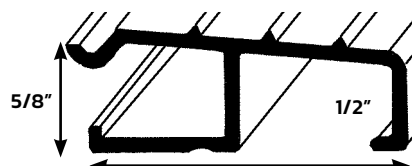

171

1-5/8" ext - Bronze & MF - 74" & 148"

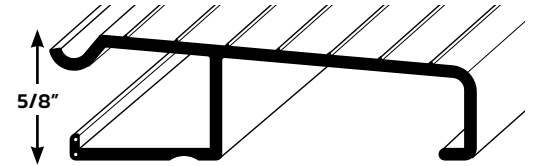

170

2" ext - Bronze & MF - 74" & 148"

EXTENDERS

some information about extenders and details

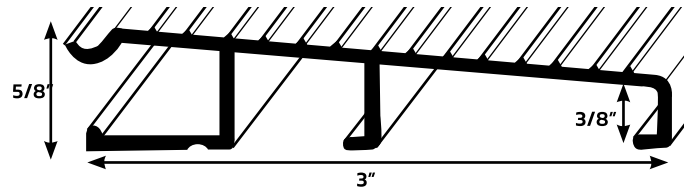

172

3" ext - Bronze & MF - 74" & 148"

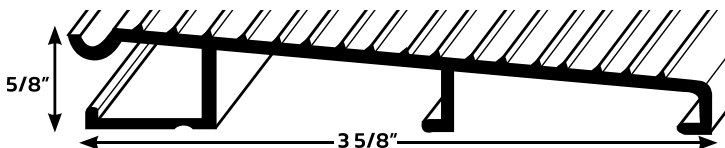

173

3-5/8" ext - Bronze & MF - 74" & 148"

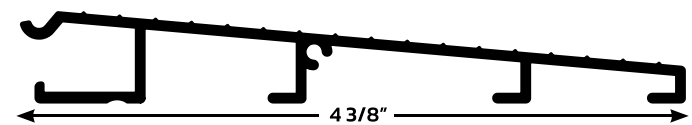

174

4-3/8" ext - Bronze & MF - 74" & 148"

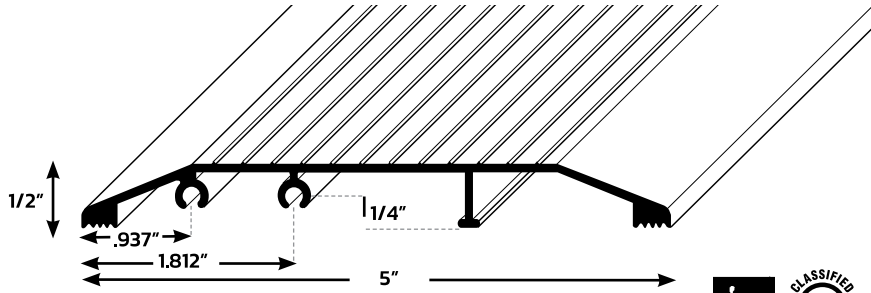

694



901
ADA Sill

- Bronze Finish Aluminum
- Mill Finish Aluminum

SIZE
1/2" X 5" X 73"

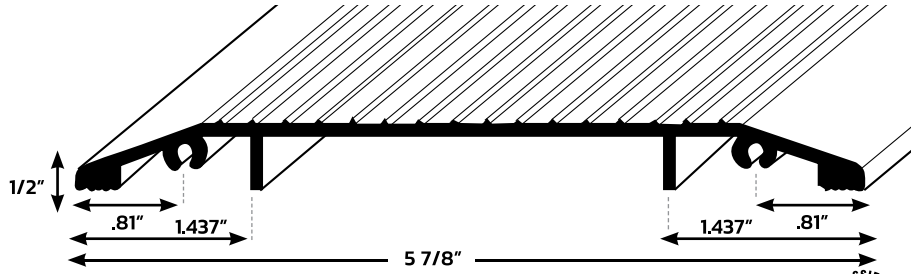

651



901
ADA Sill

- Bronze Finish Aluminum
- Mill Finish Aluminum

SIZE
1/2" X 5 7/8" X 73"

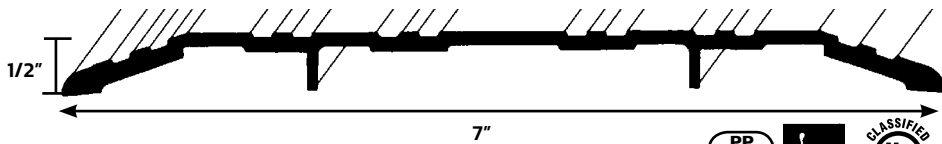

490



1/2" x 7" x 85" ADA SILL - Bronze

WEATHERSTRIPPING

3288

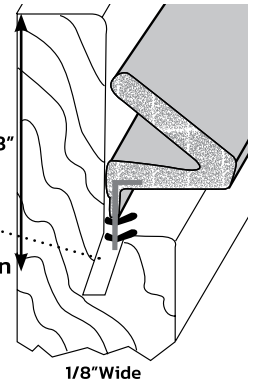

Available in
81"
97"
121"

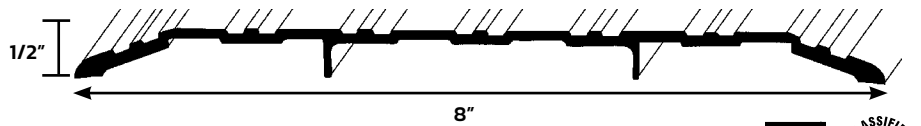

491



1/2" X 8" ADA SILL - Bronze - 85" & 97"

PREMIUM BOTTOM DOOR SEAL

W/ TAPE APPLIED
(BLUE STRIP)

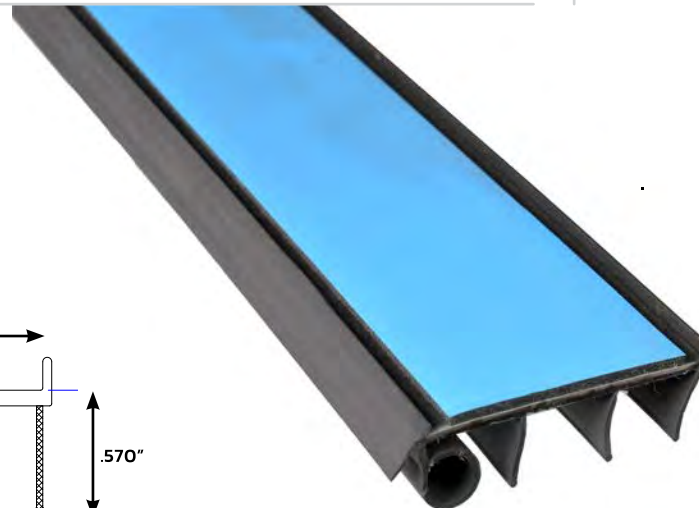
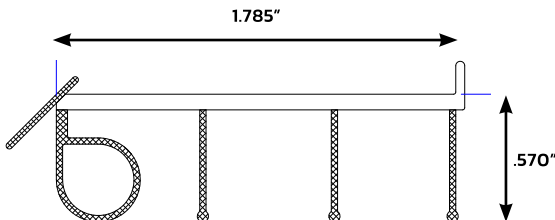





GREENFIELD *Finishing* LLC

Where we enhance the *beauty* of wood



WWW.GREENFIELDFINISH.COM

Or visit us:

2020 Horseshoe Road, Lancaster, PA 17602

Call:

717.397.5656

Fax:

717.397.2616